

Vocabulary Cards and Word Walls

Revised: June 29, 2011

Important Notes for Teachers:

- The vocabulary cards in this file match the Common Core, the math curriculum adopted by the Utah State Board of Education, August 2010.
- The cards are arranged alphabetically.
- Each card has three sections.
 - Section 1 is only the word. This is to be used as a visual aid in spelling and pronunciation. It is also used when students are writing their own “kid-friendly” definition and drawing their own graphic.
 - Section 2 has the word and a graphic. This graphic is available to be used as a model by the teacher.
 - Section 3 has the word, a graphic, and a definition. This is to be used for the Word Wall in the classroom. For more information on using a Word Wall for Daily Review – see “Vocabulary – Word Wall Ideas” on this website.
- These cards are designed to help all students with math content vocabulary, including ELL, Gifted and Talented, Special Education, and Regular Education students.

For possible additions or corrections to the vocabulary cards, please contact the Granite School District Math Department at 385-646-4239.

Bibliography of Definition Sources:

Algebra to Go, Great Source, 2000. ISBN 0-669-46151-8

Math on Call, Great Source, 2004. ISBN-13: 978-0-669-50819-2

Math at Hand, Great Source, 1999. ISBN 0-669-46922

Math to Know, Great Source, 2000. ISBN 0-669-47153-4

Illustrated Dictionary of Math, Usborne Publishing Ltd., 2003. ISBN 0-7945-0662-3

Math Dictionary, Eula Ewing Monroe, Boyds Mills Press, 2006. ISBN-13: 978-1-59078-413-6

Student Reference Books, Everyday Mathematics, 2007.

Houghton-Mifflin eGlossary, <http://www.eduplace.com>

Interactive Math Dictionary, <http://www.amathsdictionaryforkids.com/>

acute angle

acute angle

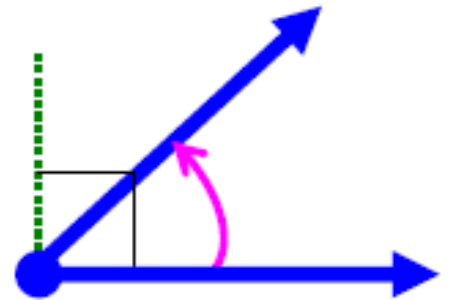

acute
angle

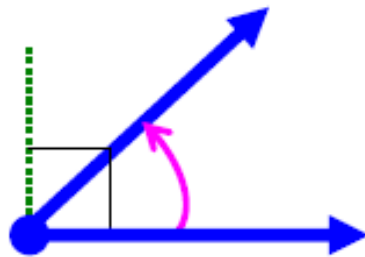

An angle with a
measure less than 90° .

add

add

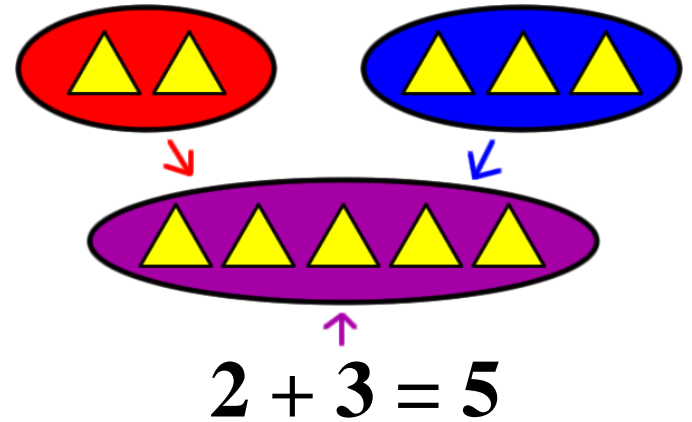

add

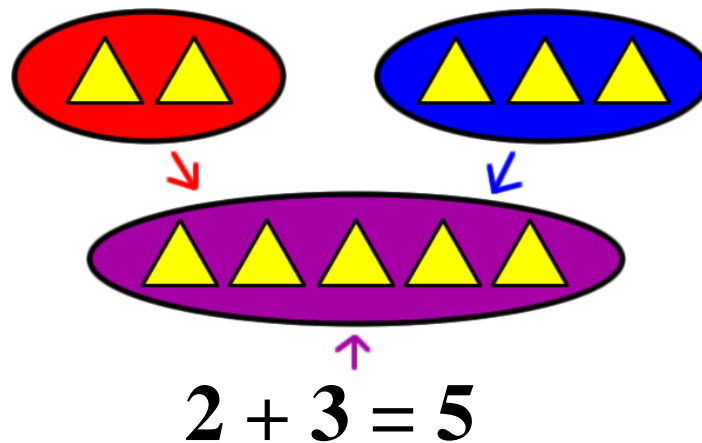

To combine, put together two or more quantities.

addend

addend

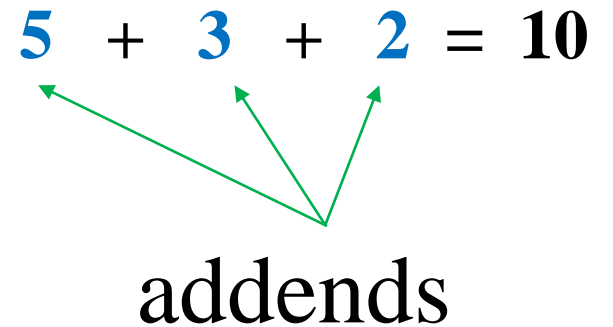

addend

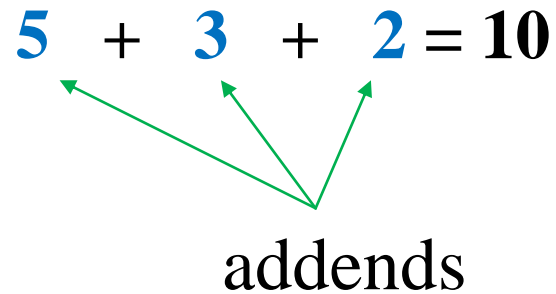

Any number
being added.

additive comparison

additive
comparison

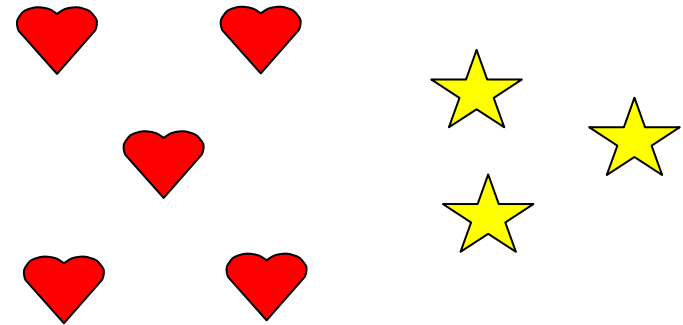

How many more hearts than stars are there?

additive
comparison

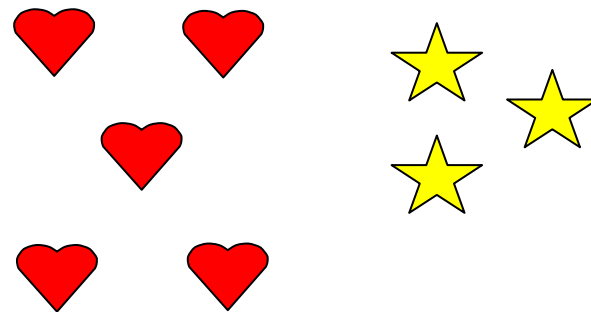

How many more hearts than stars are there?

Problems that ask
how much more
(or less) one amount
is than another.

algorithm

algorithm

$$\begin{array}{r} 24 \\ \times 3 \\ \hline 12 \\ \underline{60} \\ 72 \end{array}$$

Multiply the ones $3 \times 4 = 12$

Multiply the tens $3 \times 20 = 60$

Add the partial products

algorithm

$$\begin{array}{r} 24 \\ \times 3 \\ \hline 12 \\ \underline{60} \\ 72 \end{array}$$

Multiply the ones $3 \times 4 = 12$

Multiply the tens $3 \times 20 = 60$

Add the partial products

A step-by-step
method for
computing.

angle

angle

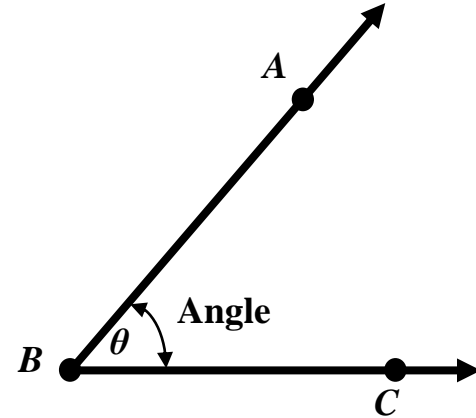

angle

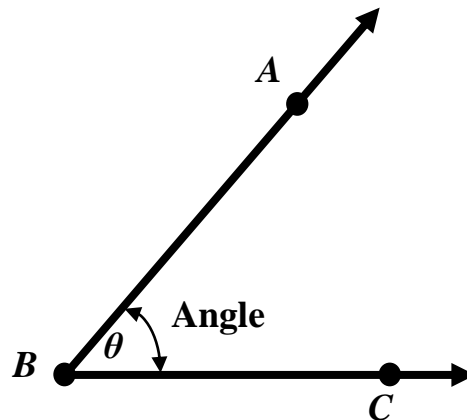

Two rays that
share an
endpoint.

angle measure

angle
measure

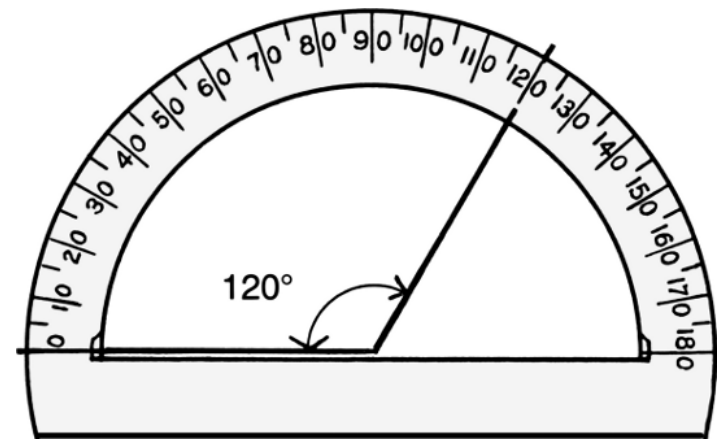

angle
measure

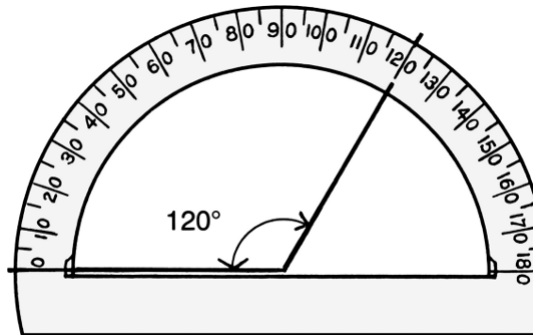

The measure of the size of an angle. It tells how far one side is turned from the other side.

A one degree angle turns through $\frac{1}{360}$ of a full circle.

arc

arc

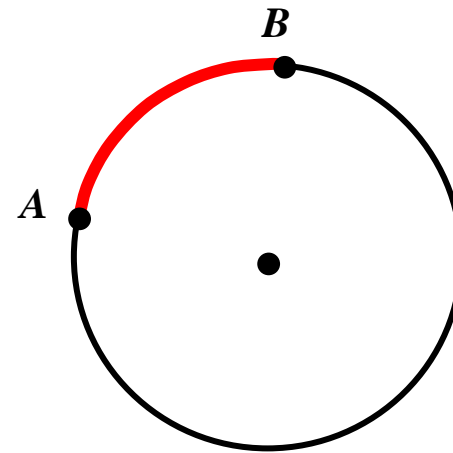

arc

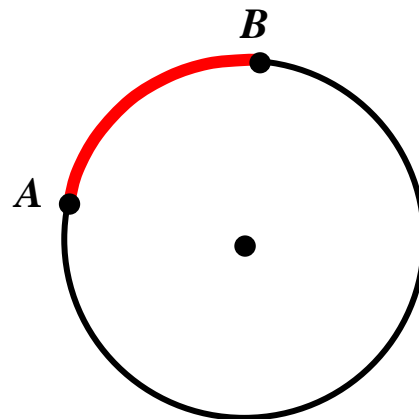

Part of a circle
between any two of
its points.

area

area

2 rows of 5 = 10 square units

or

$2 \times 5 = 10$ square units

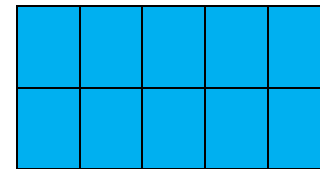

area

2 rows of 5 = 10 square units

or

$2 \times 5 = 10$ square units

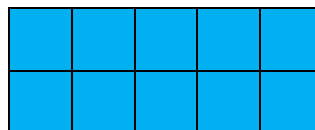

The measure, in square units, of the inside of a plane figure.

area model

area
model

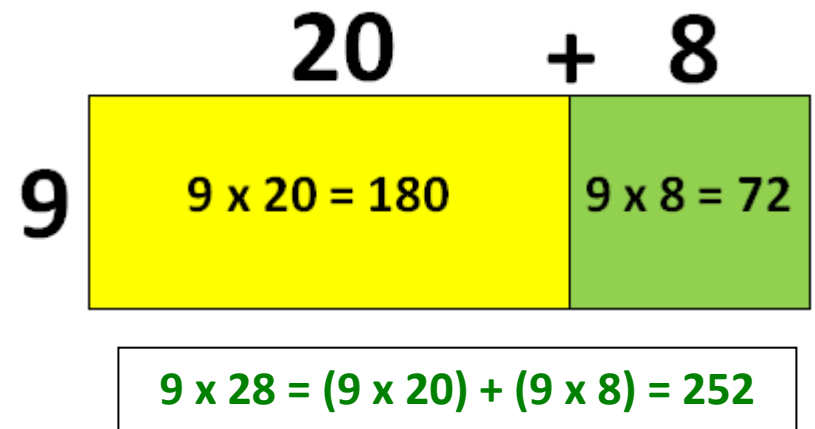

area
model

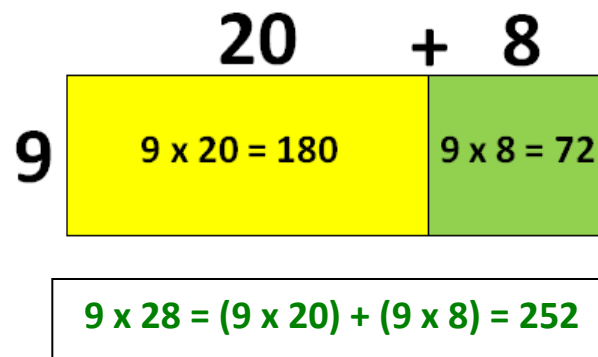

A model of multiplication that shows each place value product.

array

array

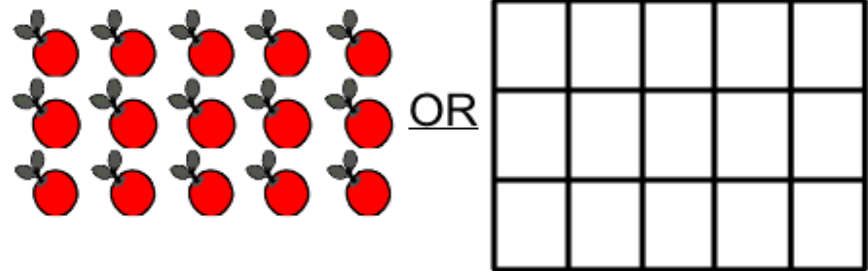

array

3 rows of 5
3 x 5

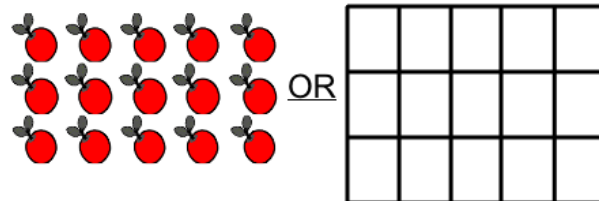

An arrangement
of objects in
equal rows.

Associative Property of Addition

**Associative
Property
of Addition**

$$(5 + 7) + 3 = 5 + (7 + 3)$$

$$12 + 3 = 5 + 10$$

$$15 = 15$$

**Associative
Property
of Addition**

$$(5 + 7) + 3 = 5 + (7 + 3)$$

$$12 + 3 = 5 + 10$$

$$15 = 15$$

Changing the grouping of three or more addends does not change the sum.

Associative Property of Multiplication

**Associative
Property of
Multiplication**

$$(5 \times 7) \times 3 = 5 \times (7 \times 3)$$
$$35 \times 3 = 5 \times 21$$
$$105 = 105$$

**Associative
Property of
Multiplication**

$$(5 \times 7) \times 3 = 5 \times (7 \times 3)$$
$$35 \times 3 = 5 \times 21$$
$$105 = 105$$

Changing the grouping of three or more factors does not change the product.

attribute

attribute

large

triangle

pink

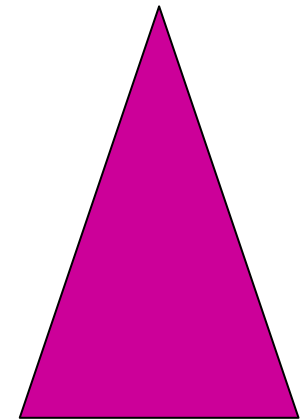

attribute

large

triangle

pink

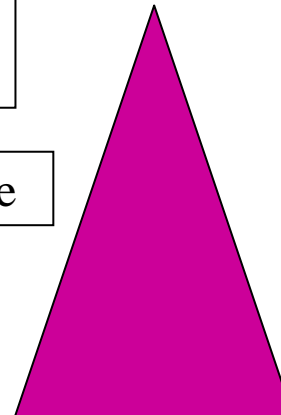

A characteristic
of an object, such
as color, shape,
size, etc.

benchmark fractions

**benchmark
fractions**

$$\frac{1}{4} \quad \frac{1}{3} \quad \frac{1}{2} \quad \frac{2}{3} \quad \frac{3}{4}$$

**benchmark
fractions**

$$\frac{1}{4} \quad \frac{1}{3} \quad \frac{1}{2} \quad \frac{2}{3} \quad \frac{3}{4}$$

Fractions that are
commonly used for
estimation.

capacity

capacity



capacity



Capacity refers to the amount of liquid a container can hold.

centimeter (cm)

centimeter (cm)

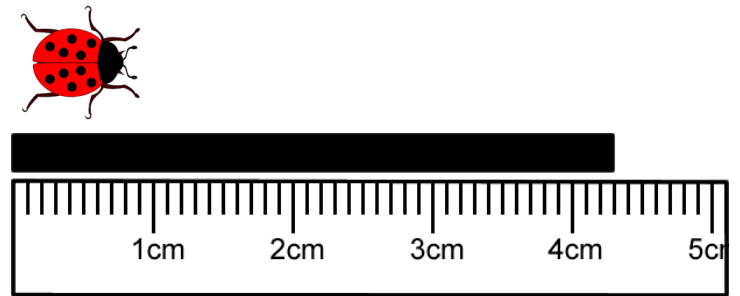

centimeter (cm)

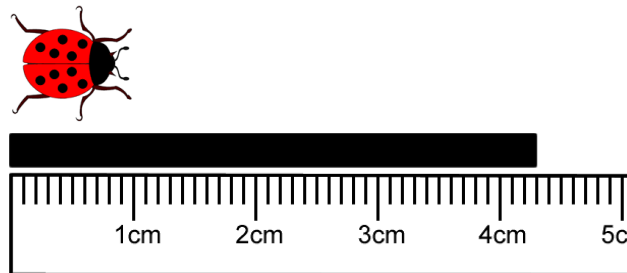

A metric unit
of length equal
to 0.01 of a
meter.

circle

circle

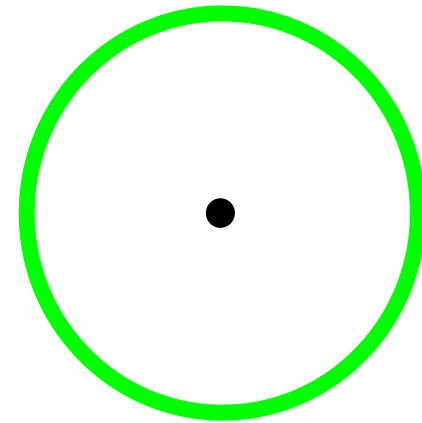

circle

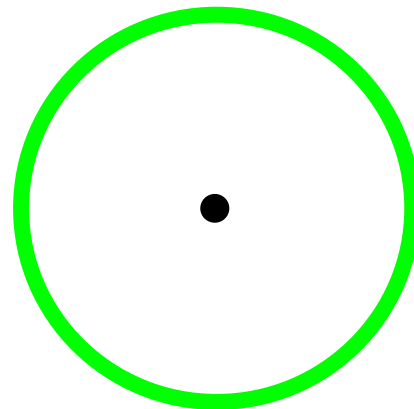

A plane figure with all points the same distance from a fixed point called a center.

classify

classify

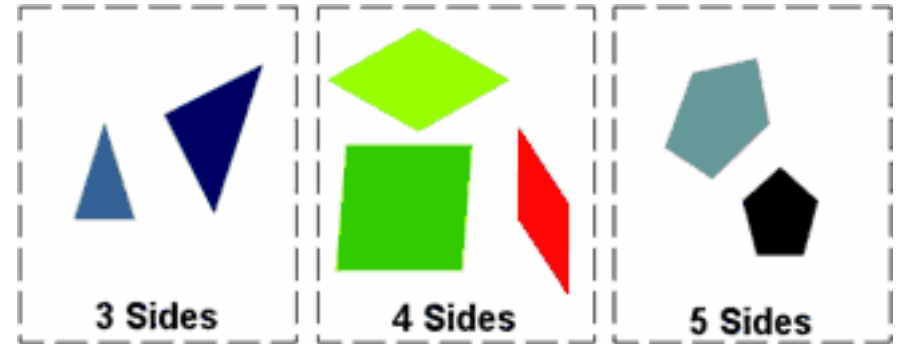

classify

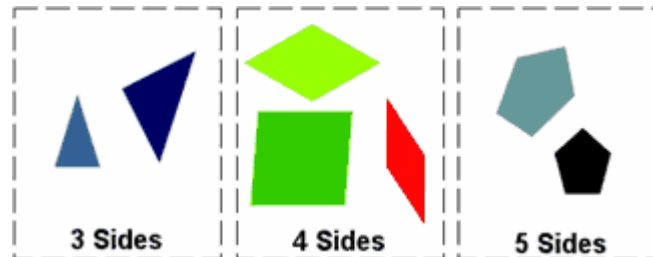

To sort into
categories
or to arrange into
groups by attributes.

common denominator

**common
denominator**

**12 is a common
denominator for**

$$\frac{2}{3} \text{ and } \frac{3}{4}$$

**common
denominator**

**12 is a common
denominator for**

$$\frac{2}{3} \text{ and } \frac{3}{4}$$

For two or more fractions, a common denominator is a common multiple of the denominators.

Commutative Property of Addition

Commutative Property of Addition

Commutative Property

$$3 + 2 = 2 + 3$$
$$a + b = b + a$$

Commutative Property of Addition

Commutative Property

$$3 + 2 = 2 + 3$$
$$a + b = b + a$$

Changing the order of the addends does not change the sum.

Commutative Property of Multiplication

Commutative Property of Multiplication

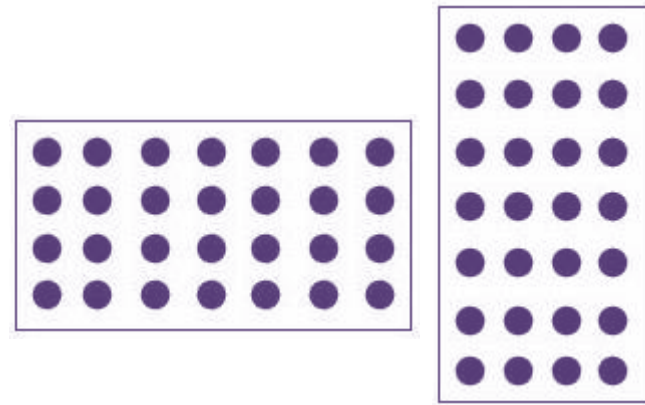

$$4 \times 7 = 7 \times 4$$

Commutative Property of Multiplication

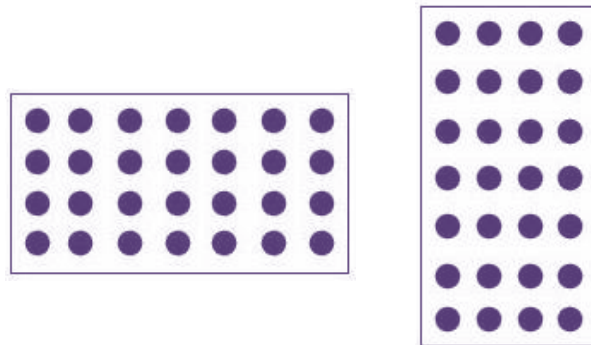

$$4 \times 7 = 7 \times 4$$

Changing the order of the factors does not change the product.

compare

compare

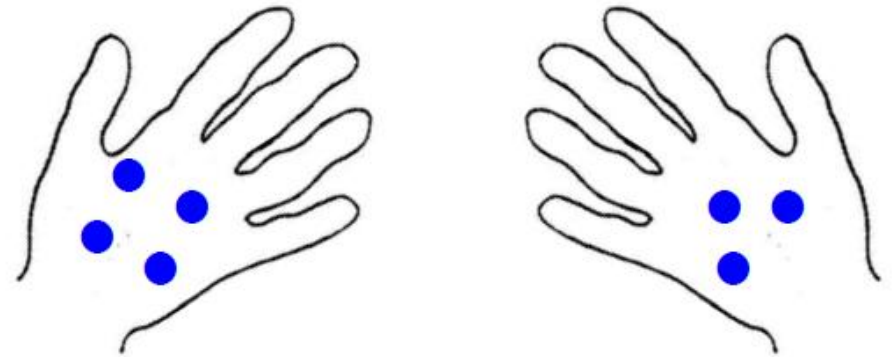

4 is more than 3

compare

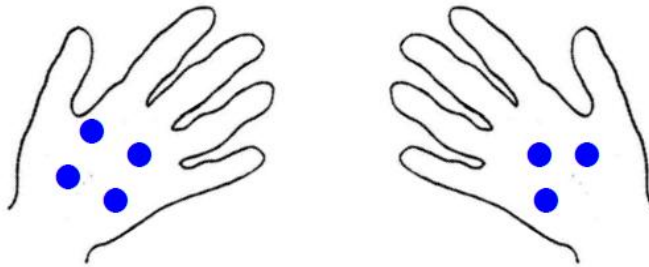

4 is more than 3

To decide if one number is greater than, less than, or equal to.

comparison bars

comparison
bars

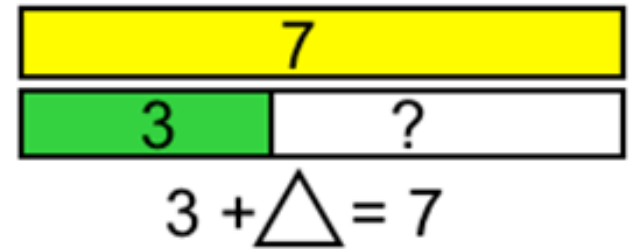

comparison
bars

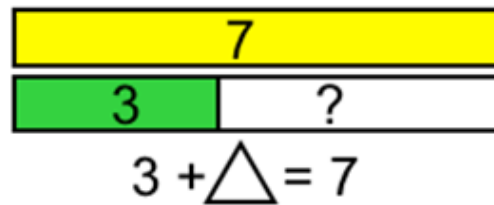

Used to represent larger and smaller amounts in a comparison situation. Can be used to represent all four operations. Different lengths of bars are drawn to represent each number.

compose

compose



compose



To put together components or basic elements.

composite number

composite
number

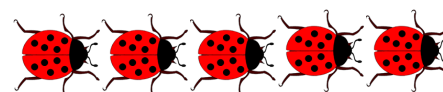

$$1 \times 6 = 6$$

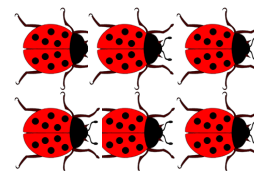

$$2 \times 3 = 6$$

6 is a composite number

composite
number

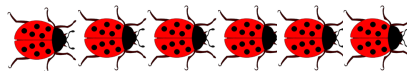

$$1 \times 6 = 6$$

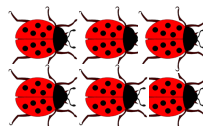

$$2 \times 3 = 6$$

6 is a composite number

A number greater than 0 that has more than two different factors.

congruent

congruent

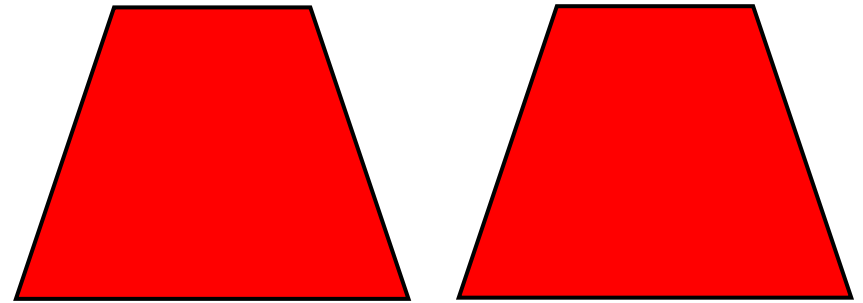

congruent

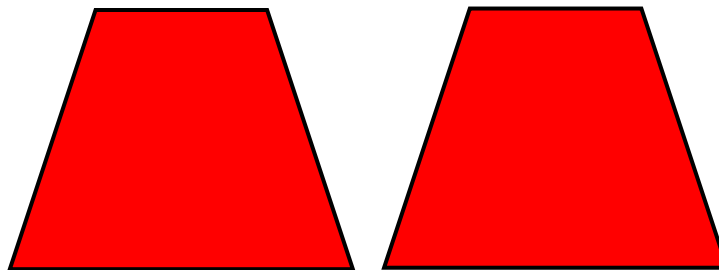

Having exactly
the same size
and shape.

cup (c)

cup (c)



cup (c)



A customary unit of
capacity.
1 cup = 8 fluid ounces.

customary system

customary
system

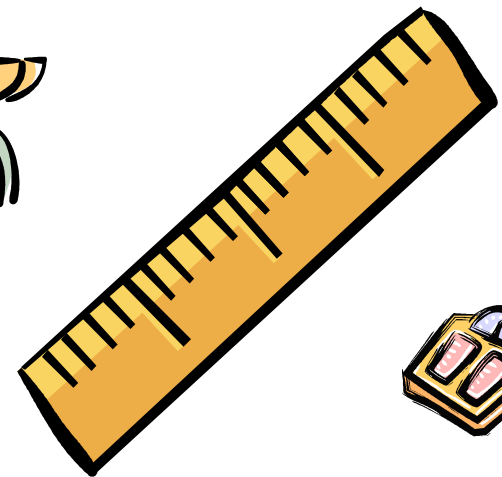

customary
system

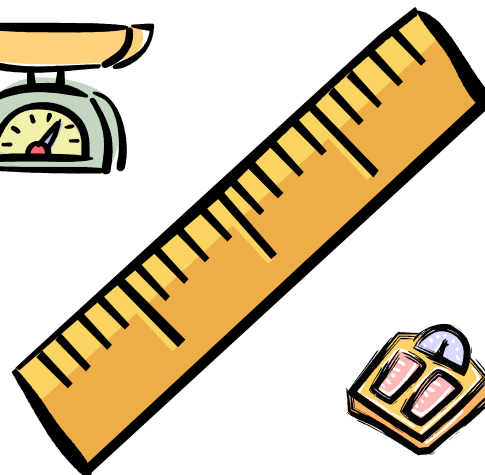







A system of measurement used in the U.S. The system includes units for measuring length, capacity, and weight.

data







data

data collecting

 car	X X X X X X X X X X			
 truck	X X X X X	car	truck	bus
 bus	X X	 	 	

data

data collecting

 car	X X X X X X X X X X			
 truck	X X X X X	car	truck	bus
 bus	X X	 	 	

A collection of information gathered for a purpose. Data may be in the form of either words or numbers.

decimal

decimal

\$29.45 53.0
0.02

decimal

\$29.45 53.0
0.02

A number with one or more digits to the right of a decimal point.

decimal fraction

decimal
fraction

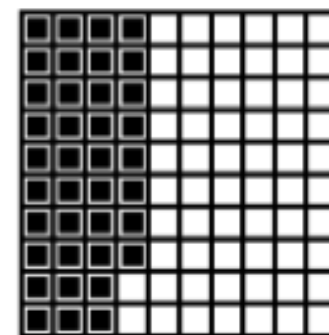

$$0.38 = \frac{38}{100}$$

decimal
fraction

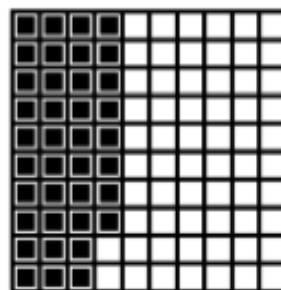

$$0.38 = \frac{38}{100}$$

A fractional number with a denominator of 10 or a power of 10. Usually written with a decimal point.

decimal notation

decimal
notation

4.73

decimal
notation

4.73

A number containing
a decimal point.

decimal point

decimal
point

\$1.55 3.2



decimal point

decimal
point

\$1.55 3.2



decimal point

A dot (.) separating
the whole number
from the fraction in
decimal notation.

decompose

decompose

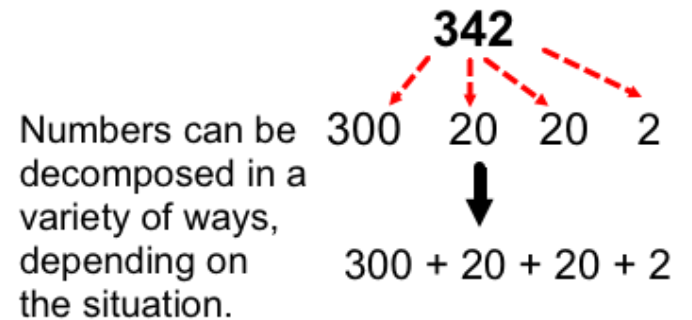

decompose

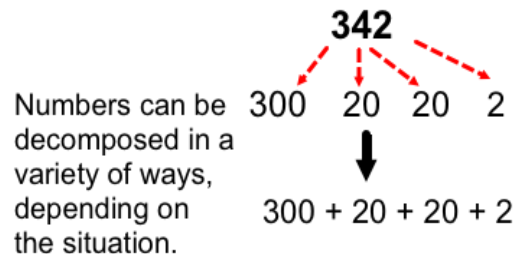

To separate into components or basic elements.

degree (angle measure)

degree (angle measure)

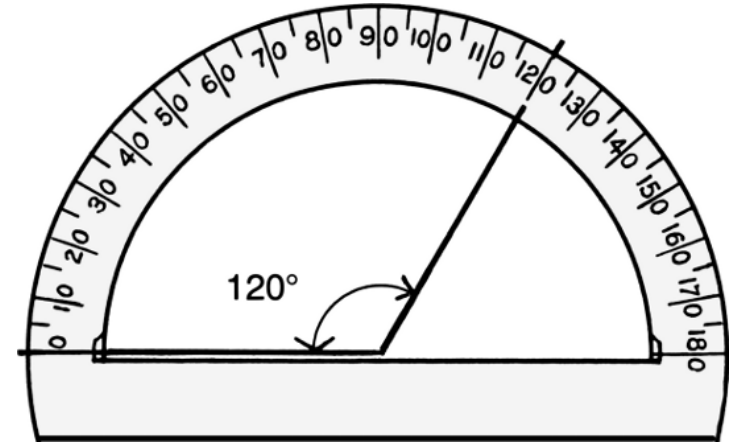

degree (angle measure)

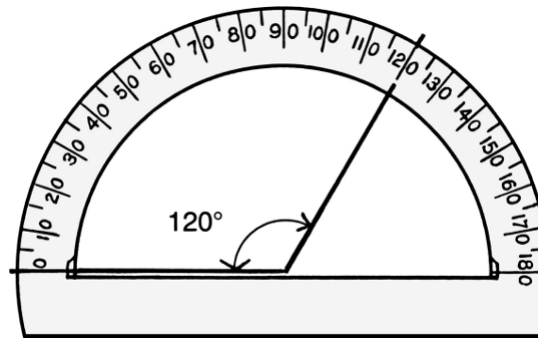

A unit for measuring angles. Based on dividing one complete circle into 360 equal parts.

denominator

denominator

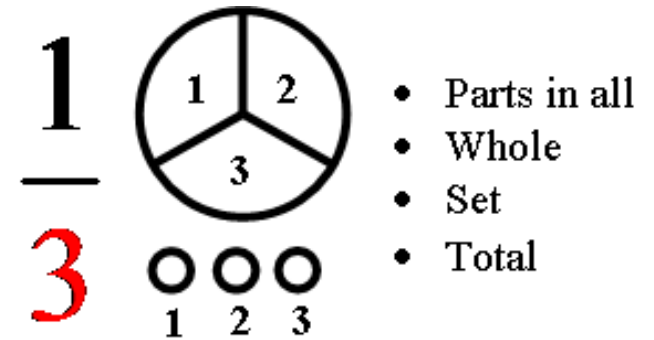

denominator

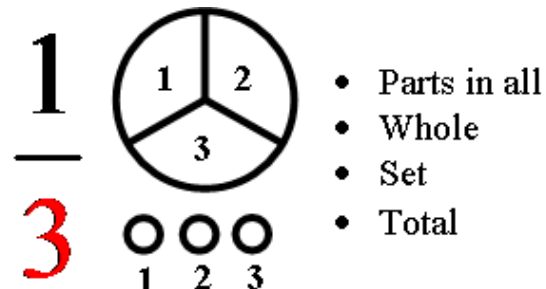

The quantity below the line in a fraction. It tells how many equal parts are in the whole.

digit

digit

0 1 2 3 4
5 6 7 8 9

digit

0 1 2 3 4
5 6 7 8 9

Any of the symbols
0, 1, 2, 3, 4, 5, 6,
7, 8, and 9.

difference

difference

$$289 - 146 = 143$$

difference



difference

$$289 - 146 = 143$$

difference



The amount that remains after one quantity is subtracted from another.

Distributive Property

Distributive Property

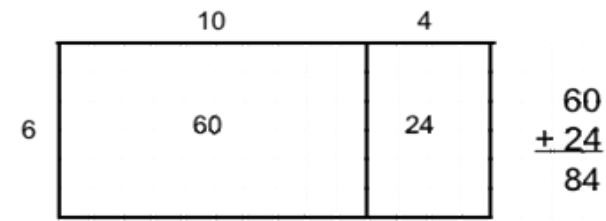

$$6 \times 14 = 6 \times (10 + 4) \text{ *Break up the 14 into } 10 + 4$$

$$\begin{array}{l} \text{60} \\ \text{+ 24} \\ \hline \text{84} \end{array}$$

Distributive Property

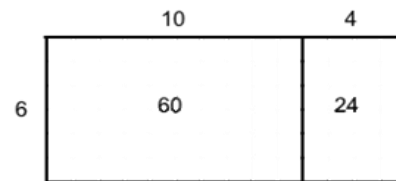

$$6 \times 14 = 6 \times (10 + 4) \text{ *Break up the 14 into } 10 + 4$$

$$\begin{array}{l} \text{60} \\ \text{+ 24} \\ \hline \text{84} \end{array}$$

When one of the factors of a product is a sum, multiplying each addend before adding does not change the product.

divide

divide

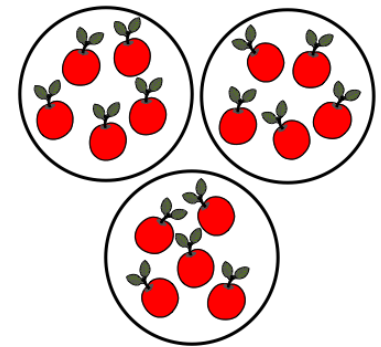

$$15 \div 3 = 5$$

divide

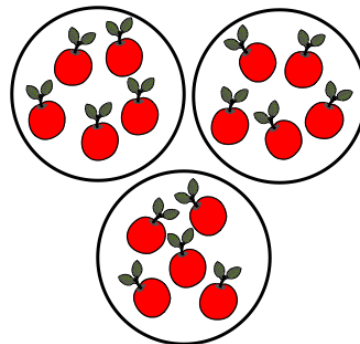

$$15 \div 3 = 5$$

To separate into equal groups and find the number in each group or the number of groups.

dividend

dividend

$$7 \overline{) 56}$$

dividend

$$7 \overline{) 56}$$

A number that is
divided by another
number.

divisor

divisor

$$\textcircled{7} \overline{) 56}$$

divisor

$$\textcircled{7} \overline{) 56}$$

The number by which
another number is
divided.

endpoint

endpoint



endpoint



A point at either end of a line segment, or a point at one end of a ray.

equal

equal

$$13 + 5 = 10 + 8$$

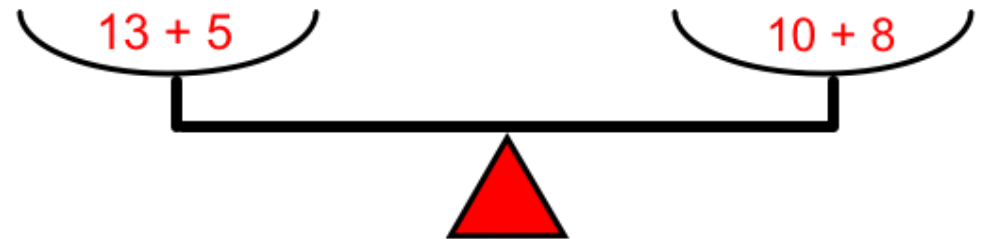

These expressions balance the scale because they are equal.

equal

$$13 + 5 = 10 + 8$$

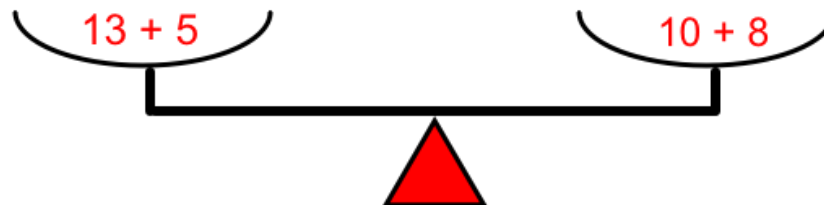

These expressions balance the scale because they are equal.

Having the same value.

equation

equation

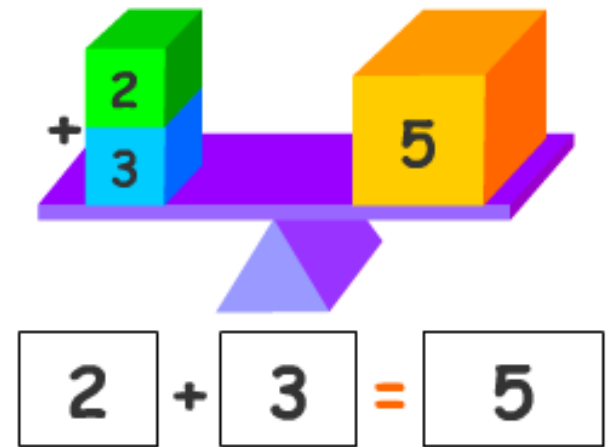

equation

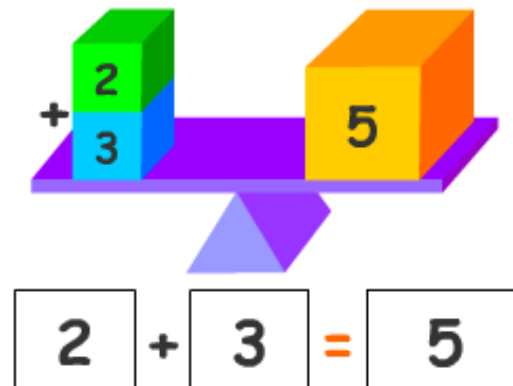

A mathematical sentence with an equals sign. The amount on one side of the equals sign has the same value as the amount on the other side.

equivalent fractions

equivalent
fractions

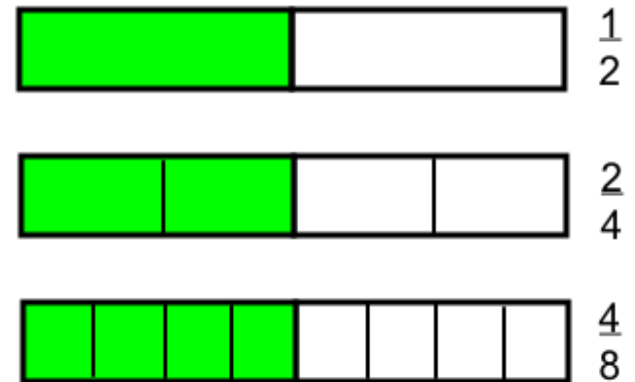

equivalent
fractions

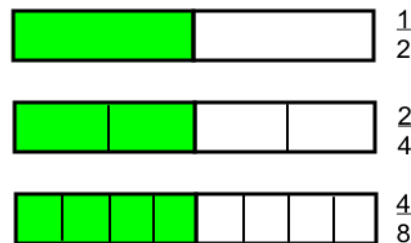

Fractions that have
the same value.

estimate

estimate



How many jelly beans are in the jar?

estimate



How many jelly beans are in the jar?

To find a number close to an exact amount; an estimate tells *about* how much or *about* how many.

evaluate

evaluate

$$42 - 13 = n$$

$$n = 29$$

evaluate

$$42 - 13 = n$$

$$n = 29$$

To find the value of
a mathematical
expression.

expanded form

expanded
form

$$263 = 200 + 60 + 3$$

expanded
form

$$263 = 200 + 60 + 3$$

A way to write numbers that shows the place value of each digit.

expression

expression

n + 4

expression

n + 4

A mathematical phrase
without an equal sign.

fact family

fact family

Fact Family for 3, 5, 15

$3 \times 5 = 15$

$15 \div 5 = 3$

$5 \times 3 = 15$

$15 \div 3 = 5$

fact family

Fact Family for 3, 5, 15

$3 \times 5 = 15$

$15 \div 5 = 3$

$5 \times 3 = 15$

$15 \div 3 = 5$

A group of related facts that use the same numbers.

Also called *related facts*.

factor

factor

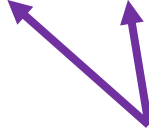
$$2 \times 6 = 12$$

factors

factor

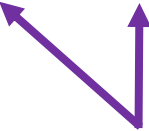
$$2 \times 6 = 12$$

factors

The whole numbers that are multiplied to get a product.

factor pairs

factor pairs

$2 \times 3 = 6$

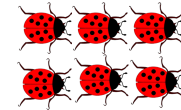

$1 \times 6 = 6$

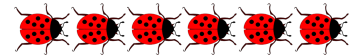

The factor pairs for 6 are
(2,3) and (1,6)

factor pairs

$2 \times 3 = 6$

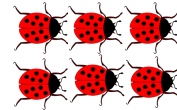

$1 \times 6 = 6$



The factor pairs for 6 are
(2,3) and (1,6)

A set of two whole numbers when multiplied, will result in a given product.

foot (ft)

foot (ft)

12 inches = 1 foot



foot (ft)

12 inches = 1 foot



A customary unit
of length.
1 foot = 12 inches.

formula

formula

To find the area of any rectangle,
multiply its length by its width.
This rule can be written as an equation,

$$A = l \times w$$

formula

To find the area of any rectangle,
multiply its length by its width.
This rule can be written as an equation,

$$A = l \times w$$

A rule that is written
as an equation.

fraction

fraction

Measurement Model

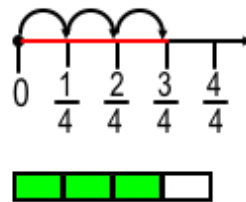

Bar Diagram
(thickened number line)

Set Model



Regional/Array Model

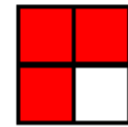

fraction

Measurement Model

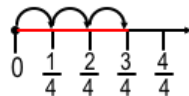

Bar Diagram
(thickened number line)

Set Model



Regional/Array Model



A way to describe a part of a whole or a part of a group by using equal parts.

function table

function table

Steamship	
Puff of Smoke input (p)	Total Blocks output (t)
1	3
2	4
3	5
Rule: $t = p + 2$	

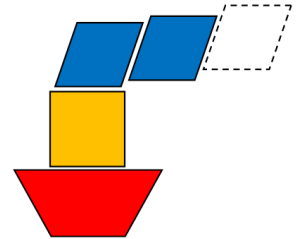

function table

Steamship	
Puff of Smoke input (p)	Total Blocks output (t)
1	3
2	4
3	5
Rule: $t = p + 2$	

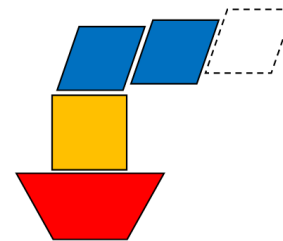

A table that lists pairs of numbers that follow a rule.

gallon (gal)

gallon (gal)

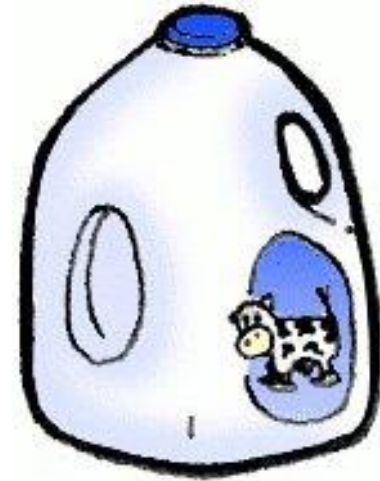

gallon (gal)

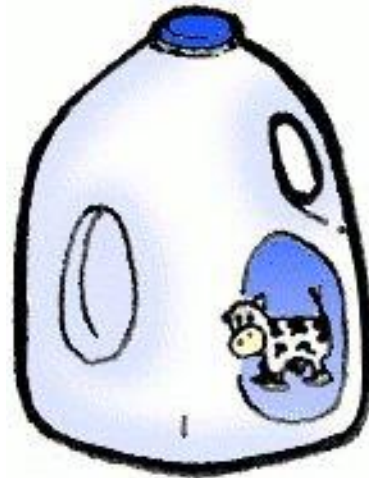

A customary unit of
capacity.
1 gallon = 4 quarts.

gram (g)

The mass of a paperclip
is about 1 gram.



gram (g)

The mass of a paperclip
is about 1 gram.



gram (g)

The standard unit of
mass in the metric
system. 1,000 grams
= 1 kilogram

greater than

greater
than



$$5 > 3$$

greater
than



$$5 > 3$$

Greater than is used to compare two numbers when the first number is larger than the second number.

hour (hr)

hour (hr)

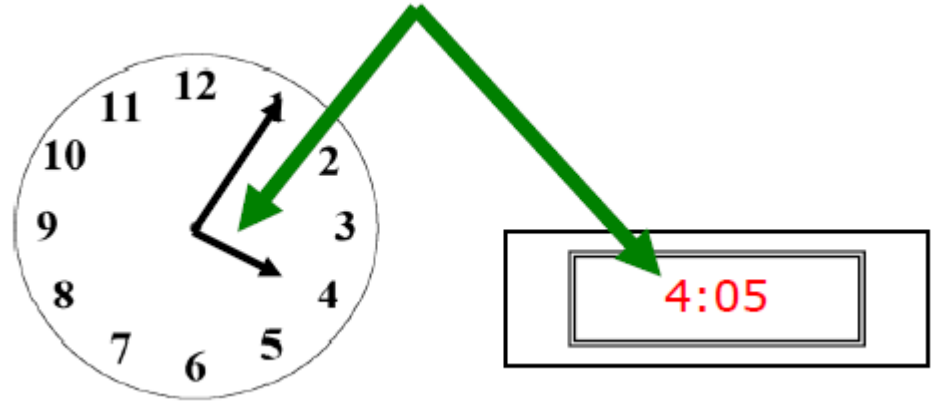

hour (hr)

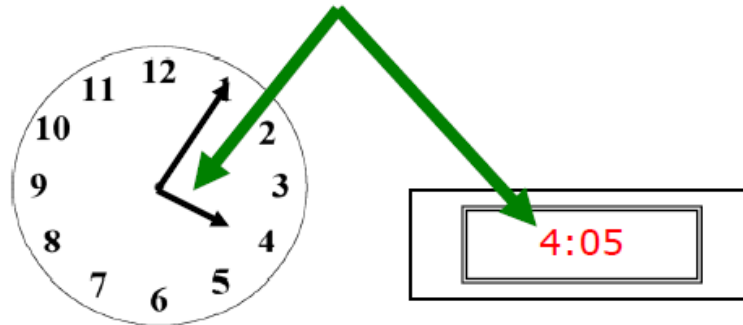

A unit of time.
1 hour = 60
minutes.
24 hours = 1 day.

hundredth

hundredth

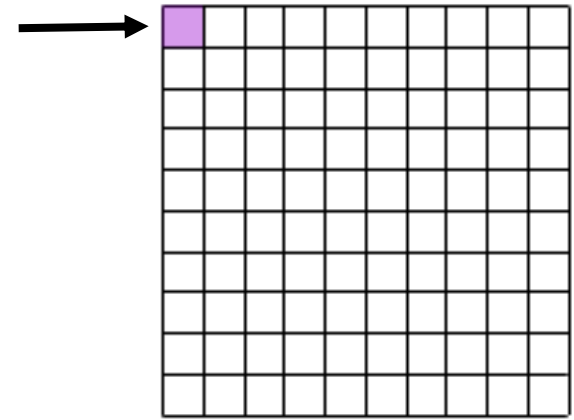

hundredth

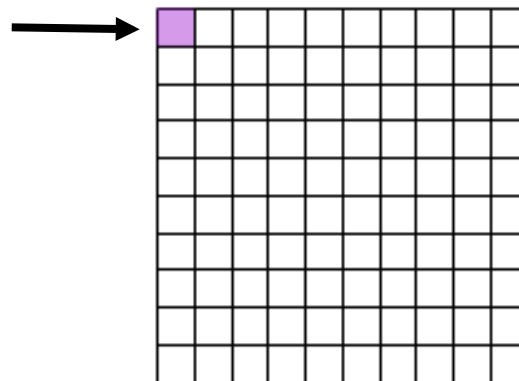

One of the
equal parts when
a whole is
divided into 100
equal parts.

hundredths

hundredths

4.38

hundredths

4.38

In the decimal numeration system, hundredths is the name of the next place to the right of tenths.

Identity Property of Addition

Identity Property
of Addition

$$8 + 0 = 8$$

Identity
Property of
Addition

$$8 + 0 = 8$$

If you add zero to a number, the sum is the same as that number.

Identity Property of Multiplication

Identity Property of Multiplication



$$1 \text{ group of } 3 = 3$$
$$1 \times 3 = 3$$

Identity Property of Multiplication



$$1 \text{ group of } 3 = 3$$
$$1 \times 3 = 3$$

If you multiply a number by one, the product is the same as that number.

improper fraction

improper fraction

$$\frac{15}{6} \quad \frac{6}{3} \quad \frac{16}{5}$$

improper fraction

$$\frac{15}{6} \quad \frac{6}{3} \quad \frac{16}{5}$$

A term for a fraction whose numerator is greater than or equal to its denominator.

inch (in)

inch (in)

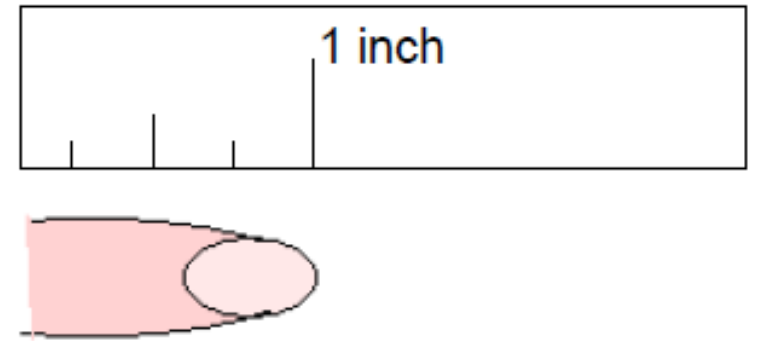

inch (in)

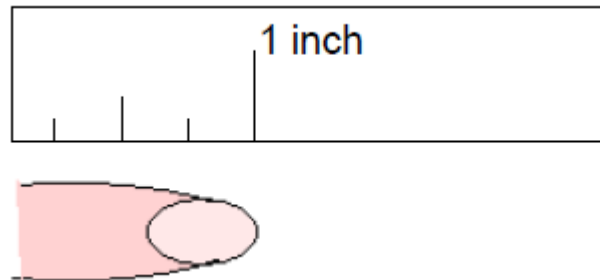

A customary unit of
length.
12 inches = 1 foot.

intersecting lines

**intersecting
lines**

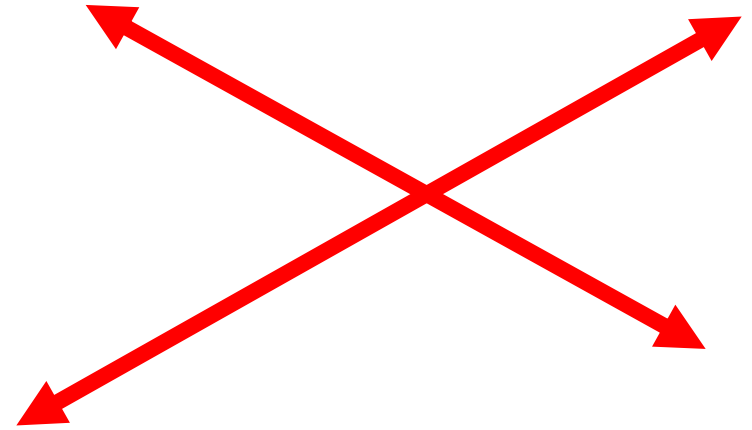

**intersecting
lines**

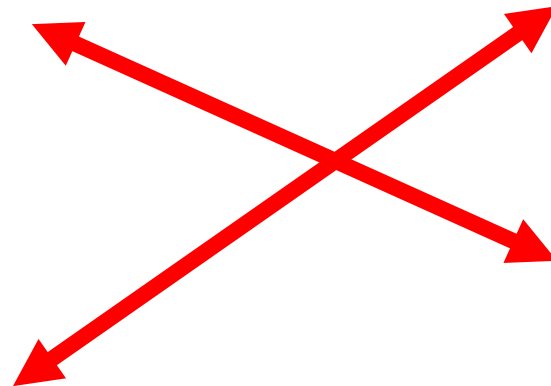

Lines that cross
at a point.

inverse operations

**inverse
operations**

**Multiplication and division
are inverse operations.**

$$8 \times 5 = 40$$
$$40 \div 5 = 8$$

**Multiplication and division
are inverse operations.**

$$8 \times 5 = 40$$
$$40 \div 5 = 8$$

**inverse
operations**

Operations that
undo each other.

kilogram (kg)

kilogram (kg)



Math book

About 2 1/2 pounds

kilogram (kg)



Math book

About 2 1/2 pounds

A metric unit of
mass equal to 1000
grams.

kilometer (km)

kilometer (km)



A kilometer (km) is about the length of 4 city blocks.

kilometer (km)

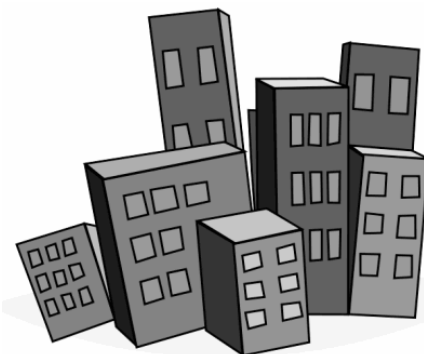

A kilometer (km) is about the length of 4 city blocks.

A metric unit of length equal to 1000 meters.

length

length

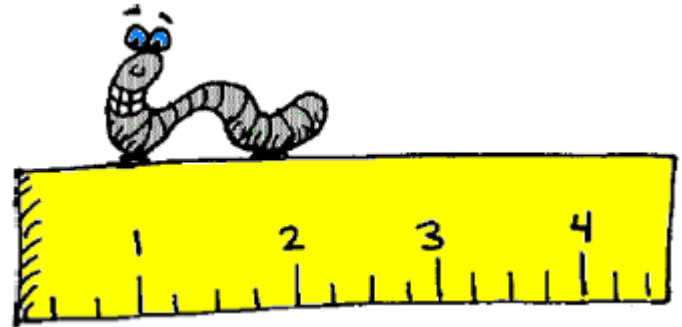

length

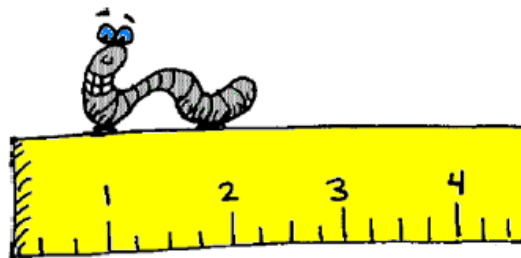

How long something is.
The distance from one
point to another.
Length is measured in units
such as inches, feet,
centimeters, etc.

less than

less than



$$3 < 5$$

less than



$$3 < 5$$

Less than is used to compare two numbers when the first number is smaller than the second number.

like denominators

like
denominators

$$\frac{3}{8} \quad \frac{5}{8} \quad \frac{7}{8}$$

like
denominators

$$\frac{3}{8} \quad \frac{5}{8} \quad \frac{7}{8}$$

Denominators in two
or more fractions that
are the same.

line

line



line



A set of connected points
continuing without end
in both directions.

line of symmetry

line of
symmetry

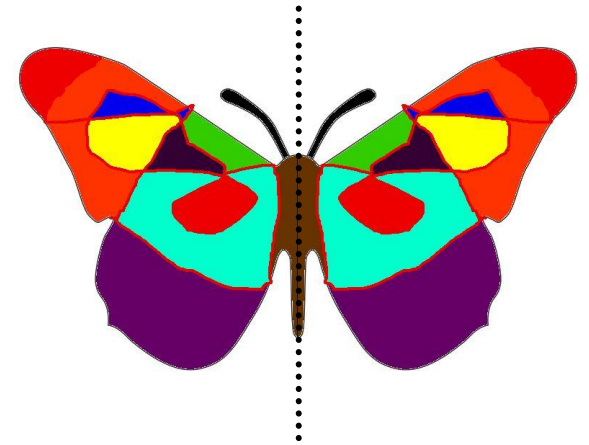

line of
symmetry

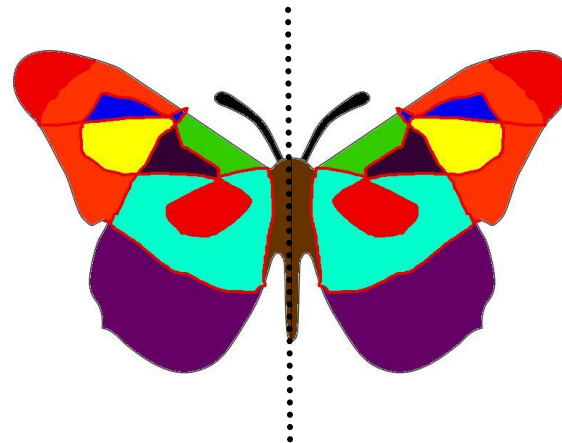

A line that divides a figure into two congruent halves that are mirror images of each other.

line plot

line plot

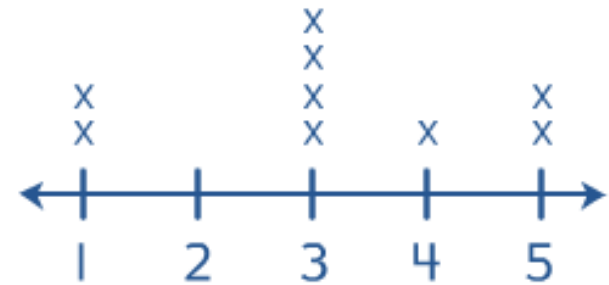

line plot

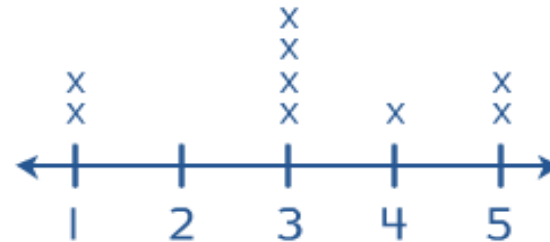

A diagram showing frequency of data on a number line.

line segment

line
segment



line
segment



A part of a line with
two endpoints.

line symmetric figures

line symmetric
figures

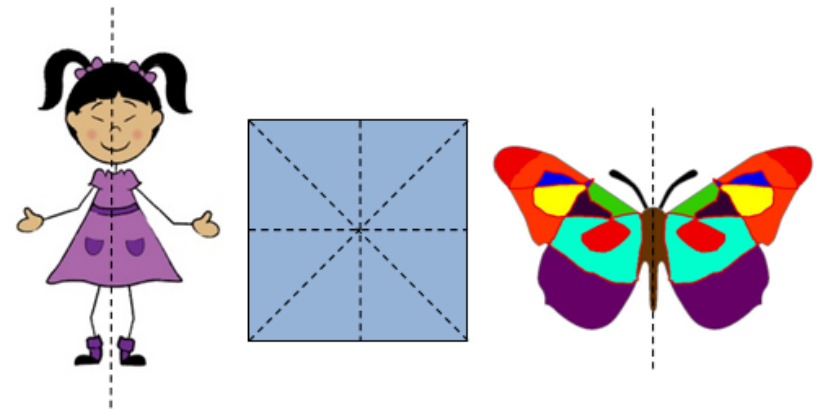

line
symmetric
figures

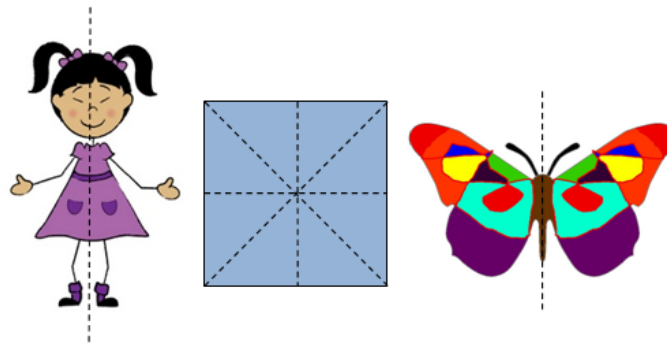

Figures that can be folded in half and its two parts match exactly.

liter (L)

liter (L)

large bottle of soda or
bottle of water



1,000 mL = 1 L

large bottle of soda or
bottle of water



1,000 mL = 1 L

liter (L)

The basic unit of
capacity in the metric
system.

1 liter = 1,000 milliliters.

lowest terms

lowest terms

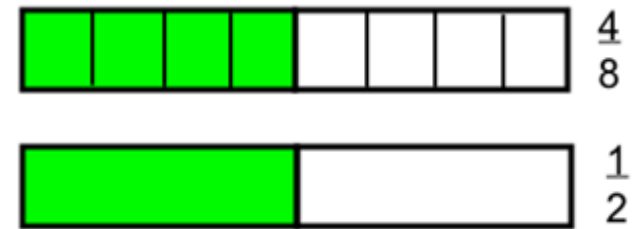

$\frac{4}{8}$ in lowest terms is $\frac{1}{2}$

lowest terms

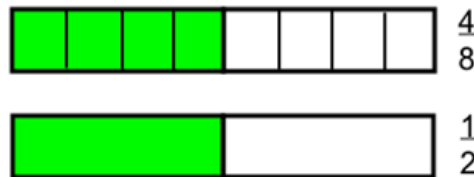

$\frac{4}{8}$ in lowest terms is $\frac{1}{2}$

When a fraction is expressed with the fewest possible pieces, it is in lowest terms. (Also called *simplest form*.)

